



CAT 328-104

Classic Advanced
Tweeter,
Ø 104mm, 8Ω



Features:

- * 104mm IDR™ Improved Dispersion Recess aluminum face plate
- * Large Hexatech™ Aluminum voice coil
- * Replaceable Acuflex™ dome / coil assembly
- * Ferro fluid cooled
- * High power handling
- * Sturdy gold plated input tags

SPECIFICATIONS

General Data		
Overall Dimensions	DxH	104mm(4.09")x46mm(1.81")
Nominal Power Handling (DIN)	P	200W
Transient Power 10ms		1000W
Sensitivity 2.83V/1M		90dB SPL
Frequency Response		See graph
Dome Material		Acuflex™ hand coated soft dome
Net Weight	Kg	0.573
Electrical Data		
Nominal Impedance	Z	8Ω
DC Resistance	Re	5.2Ω
Voice Coil Inductance @ 1KHz	LBM	0.09mH
Voice Coil and Magnet Parameters		
Voice Coil Diameter	DIA	28mm
Voice Coil Height		2.7mm
HE Magnetic Gap Height	HE	2.5mm
Max. Linear Excursion	X	
Voice Coil Former		Aluminum
Voice Coil Wire		Hexatech™ Aluminum
Number Of Layers		2
Magnet System Type		Ferrite vented
B Flux Density	B	1.5 T
BL Product	BXL	3.5 N.A
T-S Parameters		
Suspension Compliance	Cms	
Mechanical Q Factor	Qms	
Electrical Q Factor	Qes	
Total Q Factor	Qts	
Mechanical Resistance	Rms	
Moving Mass	Mms	0.44 g
Eq. Cas Air Load (liters)	VAS	
Resonant Frequency	Fs	650 Hz
Effective Piston Area	SD	6.0 cm ²

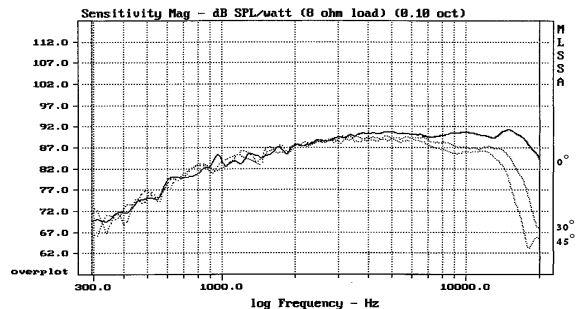
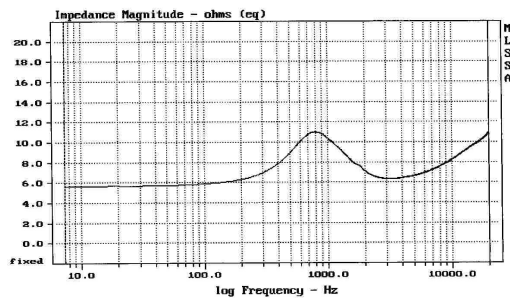
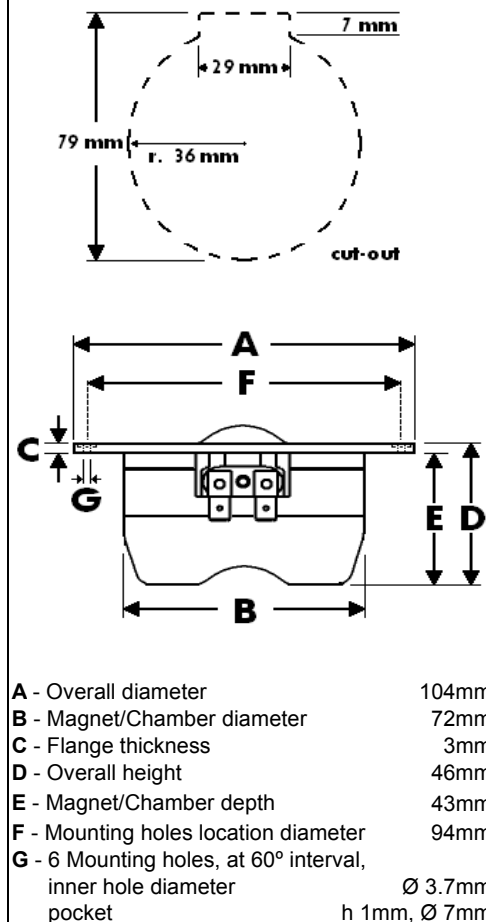

Measured on IEC baffle using Bruel & Kjaer 3144 model microphone.

Morel operate policy of continuous product design improvement, consequently specifications are subject to alteration without prior notice.